



"The peace of God ... will guard your hearts and your minds in Christ Jesus."

Do the math problems and fit the words into the correct spot to find a final message to the Philippians. Then place the letters in the boxes to complete the final sentence.

8 + 5 = <u>    </u>	4 + 3 = <u>    </u>	4 + 4 = <u>    </u>	9 - 6 = <u>    </u>
pure	noble	lovely	excellent
7 + 7 = <u>    </u>	5 + 5 = <u>    </u>	5 + 4 = <u>    </u>	15 - 9 = <u>    </u>
true	right	admirable	praiseworthy

Whatever is:                      (14)

Whatever is:                      (7)

Whatever is:                      (10)

Whatever is:                       (13)

Whatever is:                       (8)

Whatever is:                       (9)

If anything is:                       or (3)

                     (6)

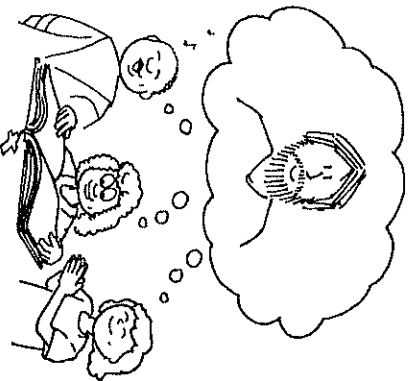

Think about such things and

the God of                      will be with you."

# Children's Worship Bulletin™

Ages 7+

Philippians 4:1-9

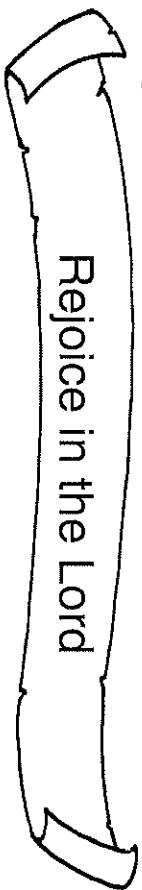

Rejoice in the Lord

Paul loved the Philippian Christians. How did he address them?

Place 3-letter words into the blanks to find some of the terms Paul used for the Philippians.

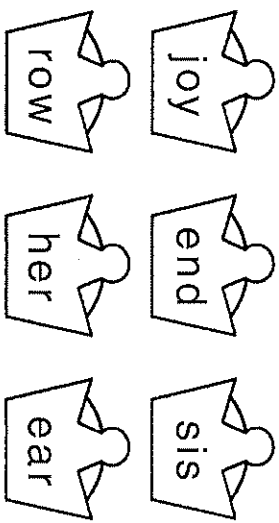

My            and             
           c            n  
           d             
 fri            s,  
 brot            s  
 and            ters.

What three things did Paul suggest the believers do – “in the Lord”?

Write the day or month described. Use the 21 numbered letters to find what Paul told the Philippian Christians to do.

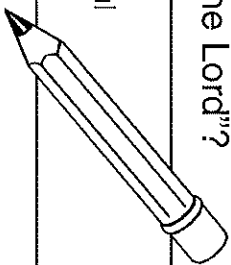

The 6th month of the year \_\_\_\_\_ 1 \_\_\_\_\_ 2 \_\_\_\_\_ 3 \_\_\_\_\_

Often the last school day of the week \_\_\_\_\_ 4 \_\_\_\_\_ 5 \_\_\_\_\_ 6 \_\_\_\_\_

The 3rd day of the week \_\_\_\_\_ 7 \_\_\_\_\_ 8 \_\_\_\_\_

The 3rd month of the year \_\_\_\_\_ 9 \_\_\_\_\_ 10 \_\_\_\_\_ 11 \_\_\_\_\_

The 8th month \_\_\_\_\_ 12 \_\_\_\_\_ 13 \_\_\_\_\_ 14 \_\_\_\_\_

The first work day of the week \_\_\_\_\_ 15 \_\_\_\_\_ 16 \_\_\_\_\_

The 4th month, known for showers \_\_\_\_\_ 17 \_\_\_\_\_ 18 \_\_\_\_\_

The 4th day, mid-week \_\_\_\_\_ 19 \_\_\_\_\_ 20 \_\_\_\_\_ 21 \_\_\_\_\_

1) \_\_\_\_\_ 8 \_\_\_\_\_ 14 \_\_\_\_\_ 16 \_\_\_\_\_ 2 \_\_\_\_\_ 21 \_\_\_\_\_

4 \_\_\_\_\_ 6 \_\_\_\_\_ 17 \_\_\_\_\_ 9 \_\_\_\_\_ in the Lord

2) \_\_\_\_\_ 12 \_\_\_\_\_ 13 \_\_\_\_\_ 10 \_\_\_\_\_ 3 \_\_\_\_\_ 20 \_\_\_\_\_

with each other in the Lord

3) \_\_\_\_\_ 5 \_\_\_\_\_ 19 \_\_\_\_\_ 1 \_\_\_\_\_ 15 \_\_\_\_\_ 18 \_\_\_\_\_ 11 \_\_\_\_\_ 7 \_\_\_\_\_

in the Lord always



Paul encouraged the Philippians with some positive suggestions as they presented their requests to God.

Think of 3-letter words that match the clues. Use the letters to find one of Paul's instructions.

three plus three

not at all good

more than warm

slang term for male

nine minus eight

1	2	3
4	5	6
7	8	9
G	10	11
13	14	15

6 \_\_\_\_\_ 8 \_\_\_\_\_ 14 \_\_\_\_\_ 13 \_\_\_\_\_ 9 \_\_\_\_\_ 4 \_\_\_\_\_ 15 \_\_\_\_\_

5 \_\_\_\_\_ 14 \_\_\_\_\_ 3 \_\_\_\_\_ 2 \_\_\_\_\_ 8 \_\_\_\_\_ 11 \_\_\_\_\_ 1 \_\_\_\_\_ 5 \_\_\_\_\_ 4 \_\_\_\_\_ 13 \_\_\_\_\_ 11 \_\_\_\_\_ 9 \_\_\_\_\_

5 \_\_\_\_\_ 14 \_\_\_\_\_ 12 \_\_\_\_\_ 9 \_\_\_\_\_ 7 \_\_\_\_\_ 2 \_\_\_\_\_ 14 \_\_\_\_\_ 10 \_\_\_\_\_

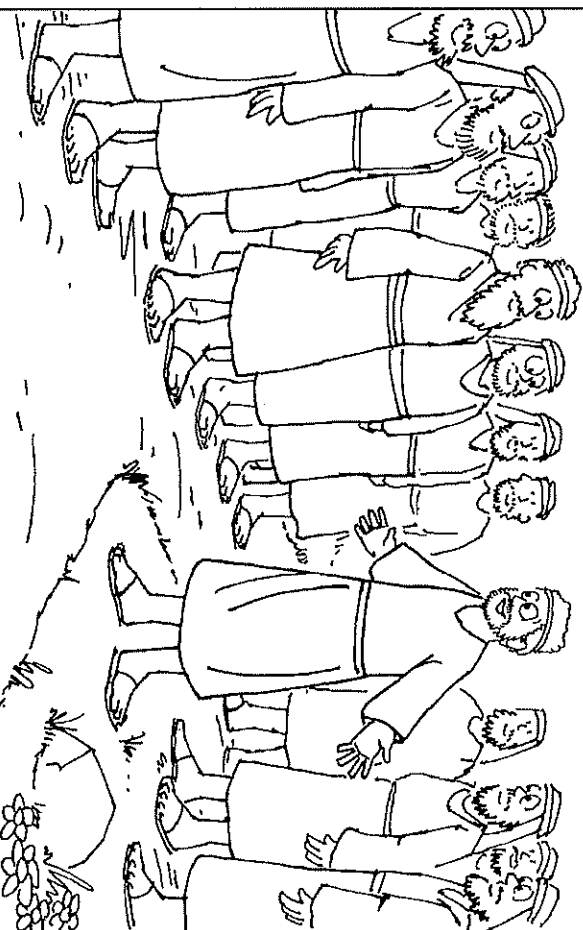

The peace of God will guard your hearts  
and your minds in ...

Trace the bubble letters.

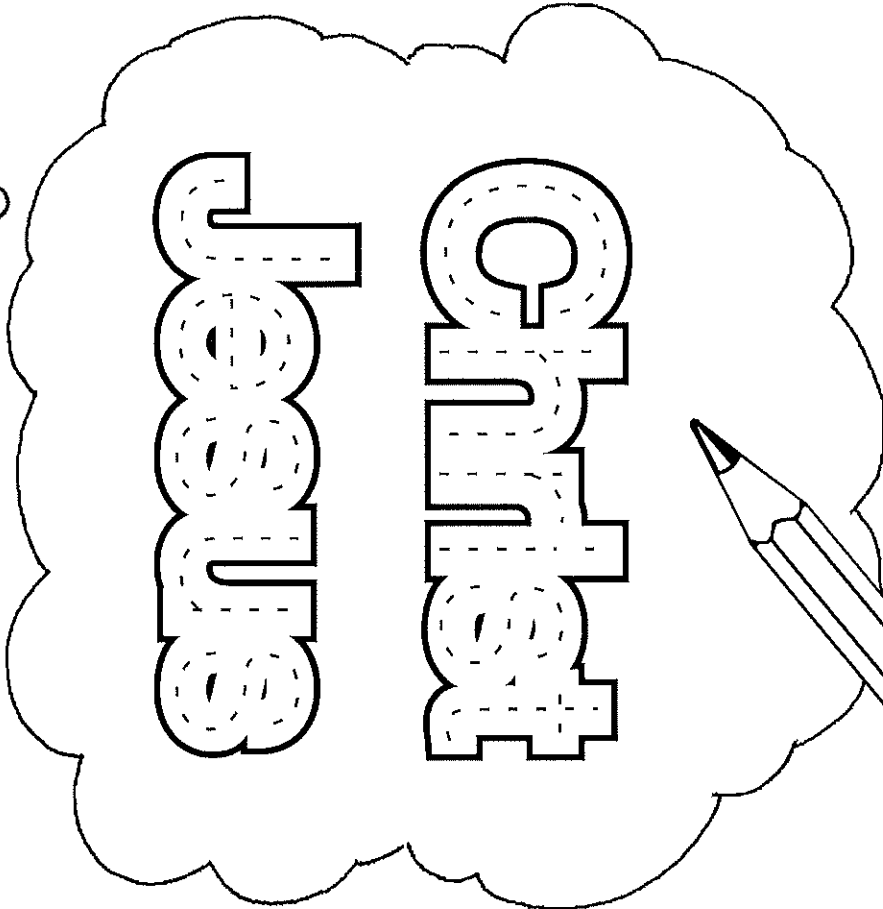
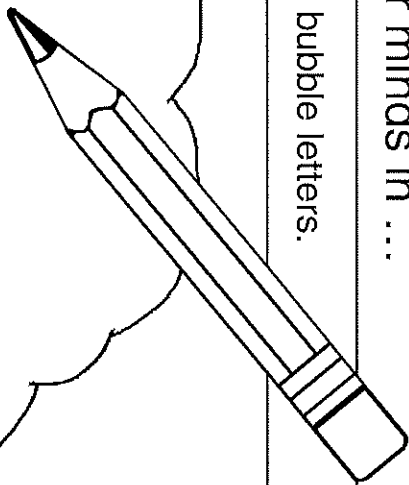

# Children's Worship Bulletin™



Ages 3+

Philippians 4:1-9

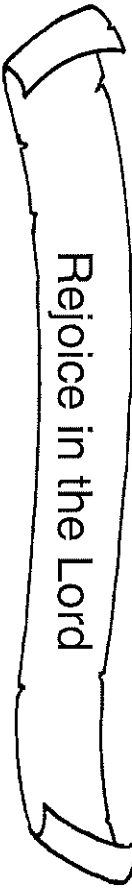

Rejoice in the Lord always!  
Let your gentleness be evident to all.

Match the puzzle pieces.

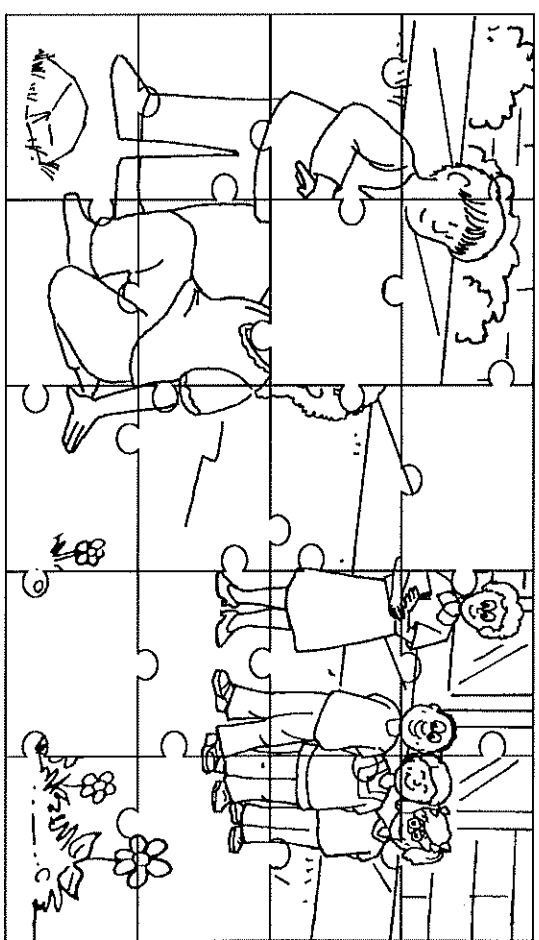
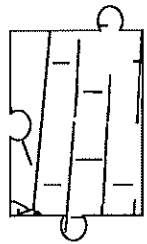
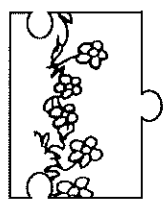
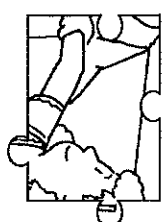

The Lord is near.  
Don't be anxious about anything!

Match the opposites.

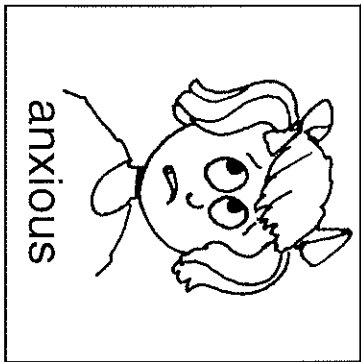

anxious

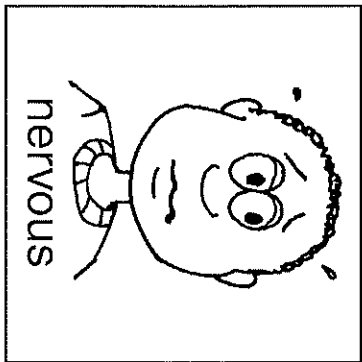

nervous

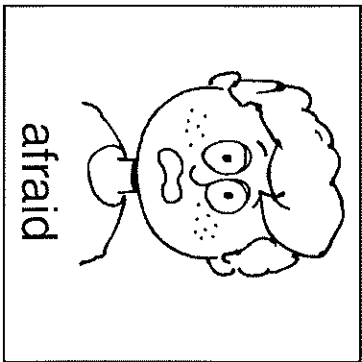

afraid

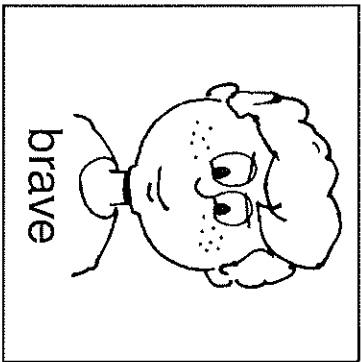

brave

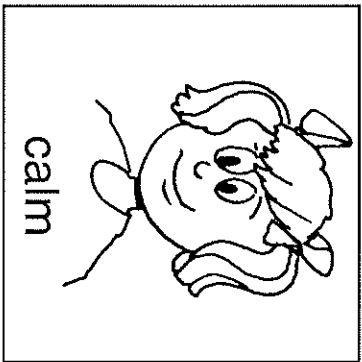

calm

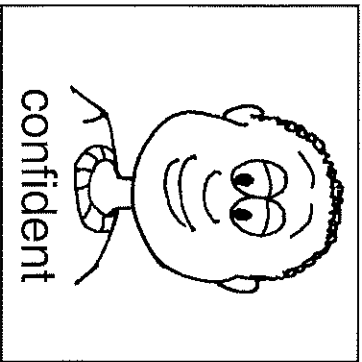

confident

In every situation present your  
requests to God in prayer.

Follow the steps to draw the picture.

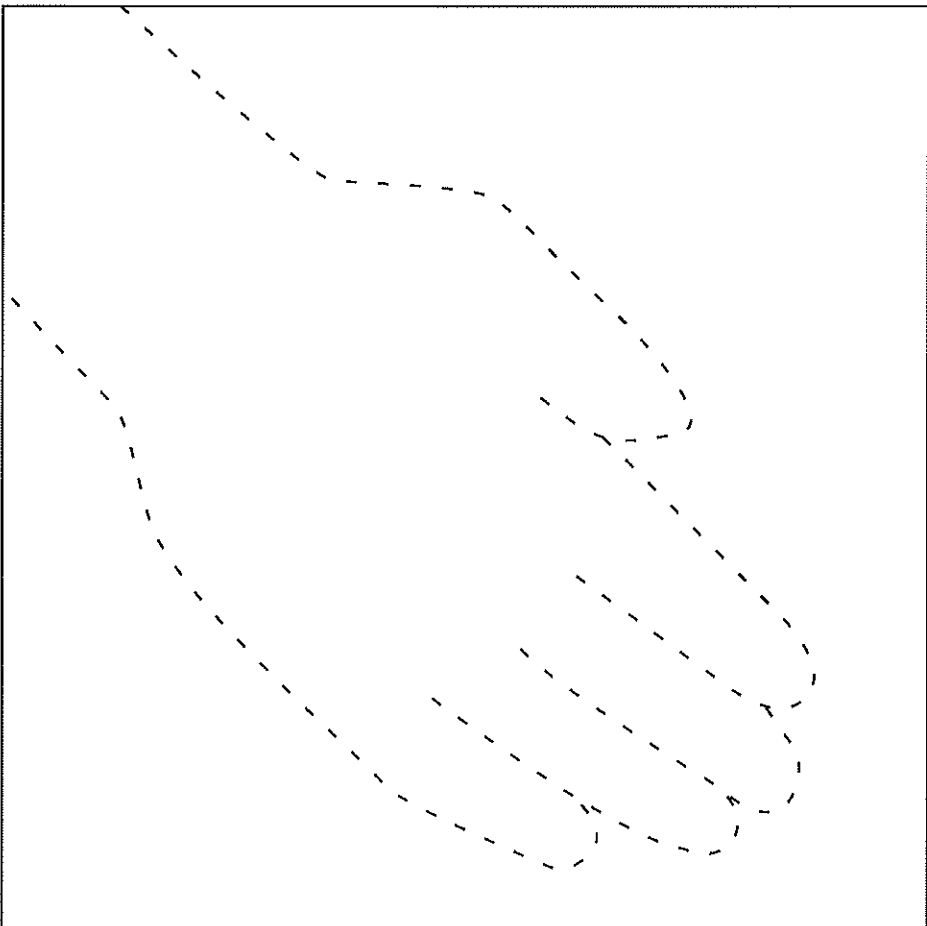
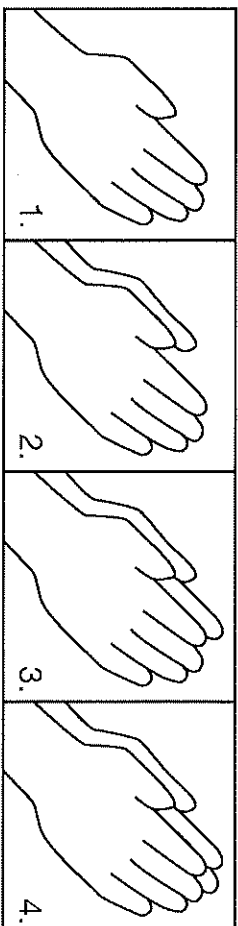



"The peace of God ... will guard your hearts and your minds in Christ Jesus."

Do the math problems and fit the words into the correct spot to find a final message to the Philippians. Then place the letters in the boxes to complete the final sentences.

$6 + 5 = 13$     $4 + 3 = 7$     $4 + 4 = 8$     $9 - 6 = 3$   
 pure   noble   lovely   excellent  
 $7 + 7 = 14$     $5 + 5 = 10$     $5 + 4 = 9$     $15 - 9 = 6$   
 true   right   admirable   praiseworthy

Whatever is: **TRUE** (14)  
 Whatever is: **NOBLE** (7)  
 Whatever is: **RIGHT** (10)  
 Whatever is: **PURE** (13)  
 Whatever is: **LOVELY** (8)  
 Whatever is: **ADMIRABLE** (9)  
 If anything is: **EXCELLENT** (3)  
**PRAISEWORTHY** (6)



Think about such things and the God of **PEACE** will be with you."

© 2014-2018 by the author. All rights reserved.

# Children's Worship Bulletin

Ages 7-12

March 22, 2020 • Philippians 4:1-9

## Rejoice in the Lord

Paul loved the Philippian Christians. How did he address them?

Place 3-letter words into the blanks to find some of the terms Paul used for the Philippians.

joy   end   sis  
 row   her   ear  
 My **JOY** and  
**CROW**n  
**EAR**s  
 fri**END**s,  
 bro**THE**r's  
 and **SIS**ters.

What three things did Paul suggest the believers do - "in the Lord"?

Write the day or month described. Use the 21 numbered letters to find what Paul told the Philippian Christians to do.

The 6th month of the year: **JUNE**  
 Often the last school day of the week: **FRIDAY**  
 The 3rd day of the week: **TUESDAY**  
 The 3rd month of the year: **MARCH**  
 The 8th month: **AUGUST**  
 The first work day of the week: **MONDAY**  
 The 4th month, known for showers: **APRIL**  
 The 4th day, mid-week: **WEDNESDAY**

1) **STAND FIRM** in the Lord  
 2) **AGREE** with each other in the Lord  
 3) **REJOICE** in the Lord always



Paul encouraged the Philippians with some positive suggestions as they presented their requests to God.

Think of 3-letter words that match the clues. Use the letters to find one of Paul's instructions.

three plus three: **SIX**  
 not at all good: **BAD**  
 more than warm: **HOT**  
 slang term for male: **GUY**  
 nine minus eight: **ONE**

**DO NOT BE ANXIOUS ABOUT ANYTHING.**



The peace of God will guard your hearts and your minds in ...

Trace the bubble letters.

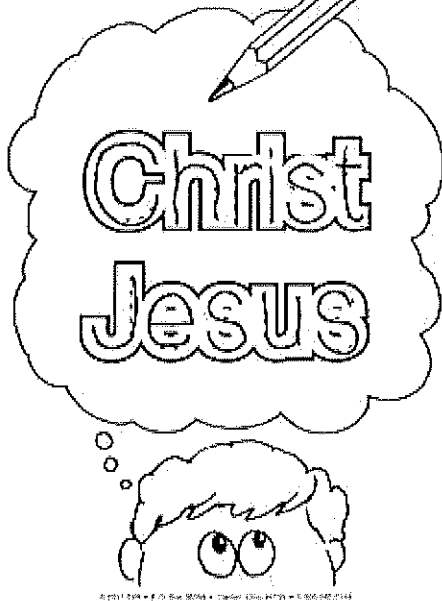

© 2017 TARA • P.O. Box 2004 • Taylor, Illinois 61875 • 618-662-0144

# Children's Worship Bulletin

Ages 3-6

March 22, 2020 • Philippians 4:1-9

Rejoice in the Lord

Rejoice in the Lord always!  
Let your gentleness be evident to all.

Match the puzzle pieces.

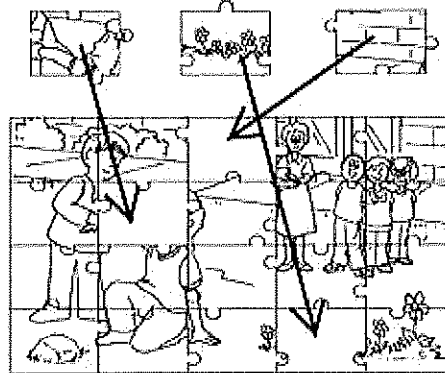

The Lord is near.  
Don't be anxious about anything!

Match the opposites.

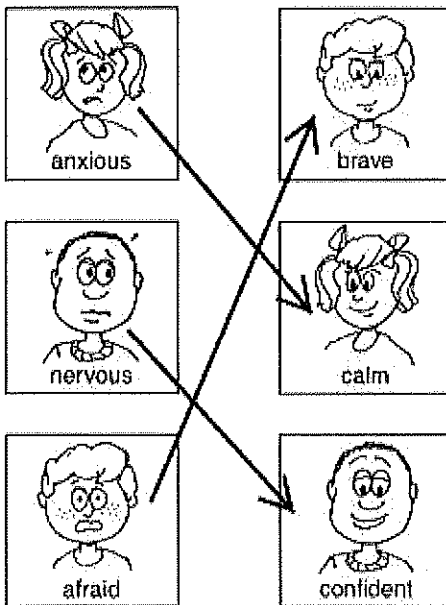

In every situation present your requests to God in prayer.

Follow the steps to draw the picture.

